

Passive harmonic filter with excellent THD reduction to <5%

APPROVALS:

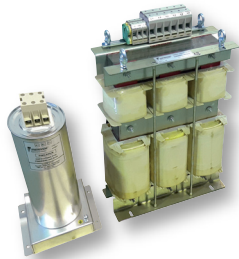

FINHRM5C. (010-110).M

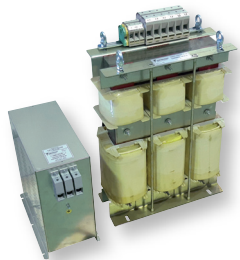

FINHRM5C. (150-210).M

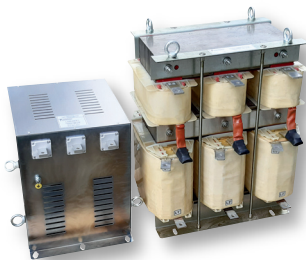

FINHRM5C. (260-750).M

FEATURES

- Rated current from 10 to 1400A
- Reduces current THD <5% with an unbalanced voltage of 2.5%
- Improves flicker and power factor
- UL Recognized
- Very compact case, open frame or enclosed

MARKETS

- VFDs and servo drives
- Processing and industrial automation
- Water and wastewater
- Oil & gas
- HVAC systems
- End user facilities

BENEFITS

- Breaker available upon request
- Finger safe protection upon request
- Ensures IEEE519 and EN61000-3-12 compliance
- Low power loss and operating temperature
- Remote power quality monitor available

ORDERING CODE

FINHRM5C	.010	.M	-60
Model	Current (A)	Connection	Frequency
		M = Terminal block	50 = 50Hertz
		V = Screw	60 = 60Hertz
		B = Bus bar	

ATTENUATION INDICATOR

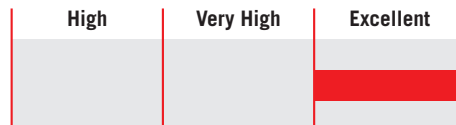

ELECTRIC DIAGRAM

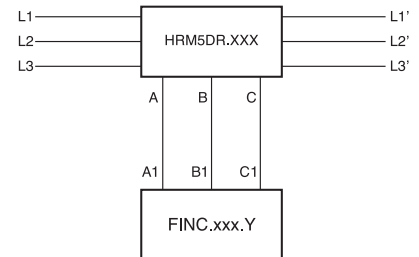

TECHNICAL SPECIFICATIONS

Nominal voltage	0-480 Vac / 690 Vac HV Version
Frequency	50 – 60 Hz
Rated current	10 - 750A
Potential test voltage phase to phase	2400 Vdc (2 sec.)
Potential test voltage phase to ground	3200 Vdc (2 sec.)
IP Protection	IP20 up to 210A IPO0 over 210A
Overload capability	4 x Rated current (Switch ON) 2 x In 10 seconds 1.5 In for 10 minutes
Climatic class	-40 to +85° C
MTBF at 40°C	250.000 Hrs

ELECTRICAL CHARACTERISTICS

FINHRM5C	Rated Current 50° C	Rated Power (KW)		Power Loss (W)		Cross Section (AWG)	Stranded (mm ²)	Terminal Block Torque (Nm)	PE Torque (Nm)
		400 Vac	480 Vac	400 Vac	480 Vac				
.010.M	10	4	5.5	165	198	26-8	1.5-10	1.6	1.6
.016.M	16	7.5	11	245	294	16-4	1.5-16	1.9	1.9
.024.M	24	11	14	263	316	14-6	1.5-25	4	4
.032.M	32	15	18.5	310	372	14-6	1.5-25	4	4
.038.M	38	18	22	380	456	12-2	2.5-50	5	5
.045.M	45	22	30	420	504	12-2	2.5-50	5	5
.060.M	60	29	35	505	606	8-0	10-70	6	6
.075.M	75	36	44	520	624	8-0	10-70	6	6
.090.M	90	43	52	530	636	0-6	16-95	12	12
.110.M	110	53	64	646	775	0-6	16-95	12	12
.150.M	150	73	87	775	930	4-250	16-150	12-20	12-20
.180.M	180	87	105	797	956	4-250	16-150	12-20	12-20
.210.M	210	105	126	815	978	2-250	35-150	10-20	10-20

CONNECTIONS

TYPICAL MEASUREMENT

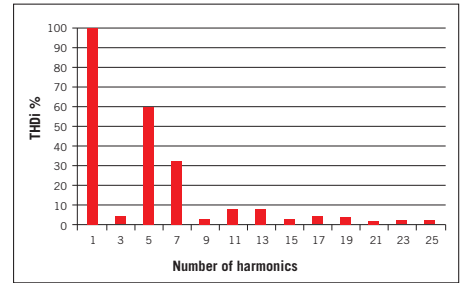

Typical measurement without FINHRM5C

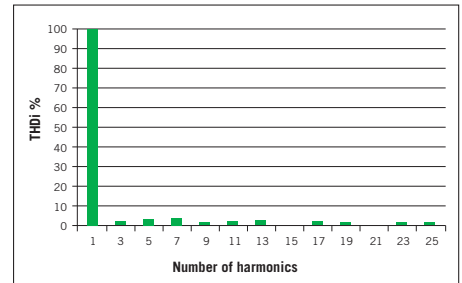

Typical measurement with FINHRM5C

FINHRM5C	Rated Current 50° C	Rated Power (KW)		Power Loss (W)		Line		Ground	
		400 Vac	480 Vac	400 Vac	480 Vac	D (mm)	Torque (Nm)	D (mm)	Torque (Nm)
.260.B	260	130	160	710	852	M8	18	M10	18
.320.B	320	160	200	725	870	M8	18	M10	18
.380.B	380	184	221	690	828	M8	18	M10	18
.470.B	470	228	273	620	744	M8	18	M10	18
.580.B	580	280	337	1000	1200	M8	18	M10	18
.650.B	650	315	378	1130	1356	M8	18	M10	18
.750.B	750	365	437	1280	1360	M8	18	M10	18

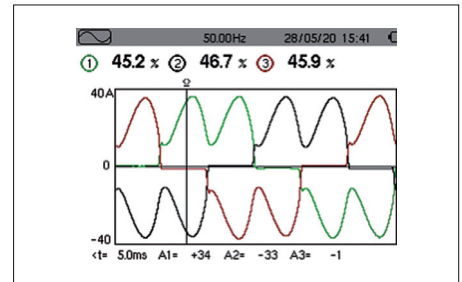

THD current Distortion from VFD - No Filtering

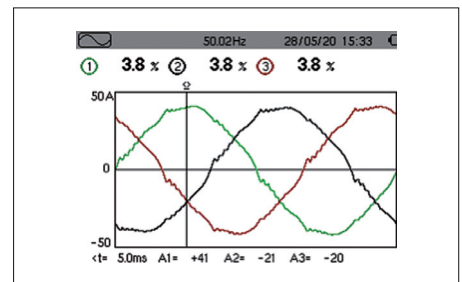

THD current Distortion from VFD - with FINHRM5C

MECHANICAL DIMENSIONS mm

FINHRM5C	A	B	C	D	E	F	G	X	Y	M	N	P	Q	R	V	Weight Kg.	Case
.010.M-50	180	145	275	120	225	8	20	150	90	75	163	198	44	44	M12	15	1
.010.M-60	180	145	275	120	225	8	20	150	90	96	169	209	36	48	M12	15	1
.016.M-50	240	160	385	126	315	8	20	200	98	75	200	235	44	44	M12	27	1
.016.M-60	240	160	385	126	315	8	20	200	98	75	163	198	44	44	M12	27	1
.024.M.*	240	160	380	128	315	8	20	200	100	75	200	235	44	44	M12	30	1
.032.M-50	240	180	380	147	320	8	20	200	118	75	275	320	44	44	M12	34	1
.032.M-60	240	180	380	147	320	8	20	200	118	75	200	235	44	44	M12	34	1
.038.M.*	300	200	460	153	397	8.5	26	260	115	75	275	320	44	44	M12	47	1
.045.M-50	300	200	450	150	395	8.5	26	260	110	85	275	320	44	44	M12	50	1
.045.M-60	300	200	450	150	395	8.5	26	260	110	116	275	372	61	50	M12	50	1
.060.M.*	300	220	470	175	400	8.5	26	260	130	136	236	276	48	36	M12	63	1
.075.M-50	360	210	550	155	480	8.5	26	260	115	116	281	321	48	36	M12	68	1
.075.M-60	360	210	550	155	480	8.5	26	260	115	136	275	327	61	50	M12	68	1
.090.M-50	360	230	560	165	475	8.5	26	260	125	116	281	321	48	36	M12	80	1
.090.M-60	360	230	560	165	475	8.5	26	260	125	116	251	303	48	36	M12	80	1
.110.M-50	360	250	565	185	475	8.5	26	260	145	136	275	326	61	50	M12	94	1
.110.M-60	360	250	565	185	475	8.5	26	260	145	116	281	321	61	50	M12	94	1

* = Mechanical dimensions suitable for both 50/60 Hz applications

CASE 1

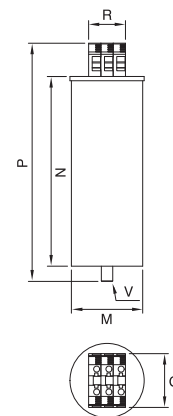
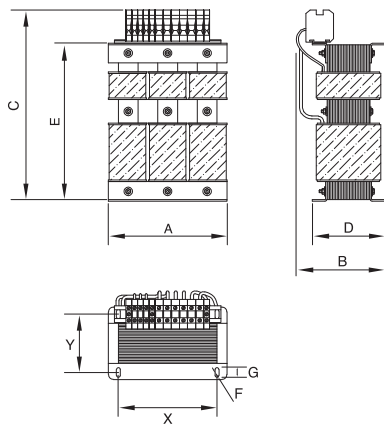

FINHRM5C	A	B	C	D	E	F	G	X	Y	M	N	P	Q	U	V	X1	Y1	Weight Kg.	Case
.150.M.*	360	350	570	235	480	8.5	26	260	190	210	432	400	380	5	M6	160	195	130	2
.180.M.*	480	320	750	205	655	11	30	360	196	210	432	400	380	5	M6	160	195	150	2
.210.M.*	480	360	765	225	635	11	30	360	175	210	432	400	380	5	M6	160	195	175	2

* = Mechanical dimensions suitable for both 50/60 Hz applications

CASE 2

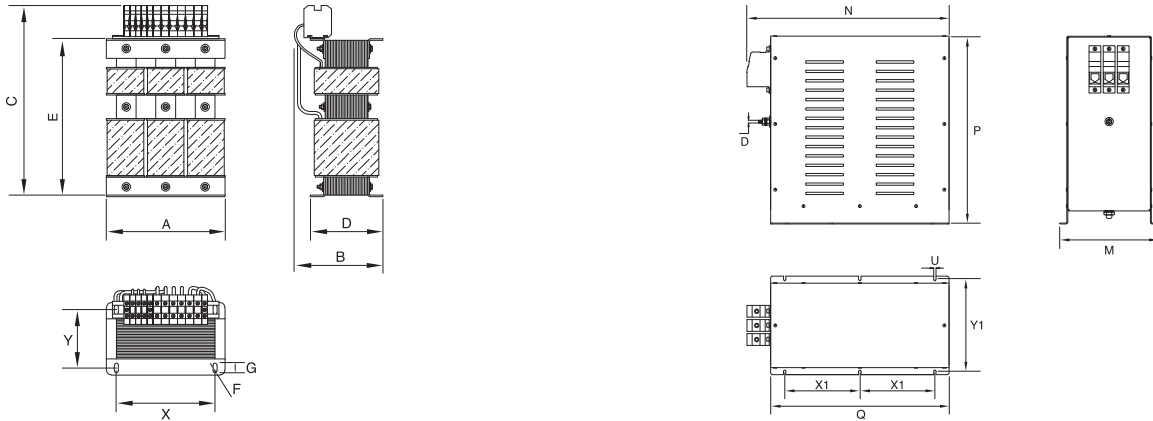

MECHANICAL DIMENSIONS mm

FINHRM5C	A	B	C	D	E	E1	F	G	I	L1	L	M	N	P	Q	R	S	T	U	V	X	Y	X1	Y1	Weight Kg.	Case
.260.B*	480	350	620	290	30	30	11	30	12	6	6	338	412	422	450	10	25	29	16	M8	360	250	410	150	198	3
.320.B*	480	370	620	300	30	30	11	30	12	6	6	338	412	422	450	10	25	29	16	M8	360	260	410	150	250	3
.380.B*	480	400	620	317	30	30	11	30	12	6	6	338	412	422	450	10	25	29	16	M8	360	275	410	150	320	3
.470.B-50	660	370	690	280	30	40	14	30	12	6	5	338	412	422	450	10	25	29	16	M8	440	235	410	150	390	3
.470.B-60	660	370	690	280	30	40	14	30	12	6	5	338	735	422	765	15	30	29	16	M8	440	235	725	150	390	3
.580.B*	660	460	690	390	30	40	14	30	12	6	10	338	735	422	765	15	30	29	16	M8	440	345	725	150	490	3
.650.B-50	660	440	790	344	30	40	14	30	12	6	10	338	735	422	765	15	30	29	16	M8	440	299	725	150	530	3
.650.B-60	660	440	790	344	30	40	14	30	12	6	10	338	570	422	600	15	30	29	16	M8	440	299	560	150	530	3
.750.B-50	660	460	790	363	30	40	14	30	12	6	10	338	735	422	765	15	30	29	16	M8	440	345	725	150	550	3
.750.B-60	660	460	790	363	30	40	14	30	12	6	10	338	570	422	600	15	30	29	16	M8	440	345	560	150	550	3

* = Mechanical dimensions suitable for both 50/60 Hz applications

CASE 3

